



Argo klimatske naprave 2023

GENERALNI UVOZNIK ZA



improve your life

X3 KLIMATSKE NAPRAVE

X3 SPLIT

X3 PAKET

X3 Talne in visokozmogljive kanalne klimatske naprave

Ecolight plus | Charm plus

Klimatske naprave za delovanje pri nizkih zunanjih temperaturah

Klimatske naprave brez zunanje enote in ULISSE ECO – SPLIT konzola

STENSKE – ENOJNE SPLIT KLIMATSKE NAPRAVE



(Standardni)
Infrardeči
daljinski
upravljalnik



(Opcijsko)
Žični krmilnik s
tedenskim
časovnikom

3 načini mirovanja	3D pretok zraka	Preprečevanje hladnega zraka	LED	Timer	Pametno odtajevanje	Auto+	"Turbo" funkcija	Samodejna diagnoza	Samodejni vnovični zagon pomnilnika	Hitrost ventilatorja
Mono&multi združljivost	Min. temp. ogrevanje	Min. temp. hlajenje	8 °C ogrevanje	iFeel	Prihranite energijo	Zaklepanje za otroke	WiFi nadzor	Hladna plazma	Žično upravljanje (opcijsko)	Krmiljenje vrat (opcijsko)

A⁺⁺ Hlajenje

A⁺ Ogrevanje (povprečna sezona)

A⁺⁺⁺ Ogrevanje (toplejša sezona)

Koda	Model	Nominalna (min.–max.) zmogljivost hlajenja (kW)	Nominalna (min.–max.) zmogljivost ogrevanja (kW)
398000817	Model notranje enote	2.70 (0.80 – 3.80)	3.00 (0.90 – 4.25)
398000818	Model zunanje enote		
398000819	Model notranje enote	3.51 (0.90 – 4.40)	3.81 (0.90 – 4.70)
398000820	Model zunanje enote		
398000821	Model notranje enote	5.20 (1.00 – 6.30)	5.60 (1.10 – 6.60)
398000822	Model zunanje enote		
398000823	Model notranje enote	7.10 (2.10 – 8.85)	7.80 (1.80 – 9.45)
398000824	Model zunanje enote		

STENSKE -25 °C – ENOJNE SPLIT KLIMATSKE NAPRAVE



(Standardni)
Infrardeči
daljinski
upravljalnik



(Opcijsko)
Žični krmilnik s
tedenskim
časovnikom



A⁺⁺

Hlajenje

A⁺

Ogrevanje (povprečna sezona)

A⁺⁺⁺

Ogrevanje (toplejša sezona)

Koda	Model		Nominalna (min.–max.) zmogljivost hlajenja (kW)	Nominalna (min.–max.) zmogljivost ogrevanja (kW)
398000852	Model notranje enote	X3I ECO PLUS 27 HL WF LH	2.70 (0.80 – 3.80)	3.00 (0.90 – 4.25)
398000853	Model zunanje enote	X3I ECO PLUS 27 SH LH		
398000854	Model notranje enote	X3I ECO PLUS 35 HL WF LH	3.51 (0.90 – 4.40)	3.81 (0.90 – 4.70)
398000855	Model zunanje enote	X3I ECO PLUS 35 SH LH		
398000864	Model notranje enote	X3I ECO PLUS 52 HL WF LH	5.20 (1.00 – 6.10)	5.60 (1.10 – 6.60)
398000865	Model zunanje enote	X3I ECO PLUS 52 SH LH		
398000866	Model notranje enote	X3I ECO PLUS 71 HL WF LH	7.10 (2.00 – 8.81)	7.80 (1.80 – 9.45)
398000867	Model zunanje enote	X3I ECO PLUS 71 SH LH		

TALNE -22 °C – ENOJNE SPLIT KLIMATSKE NAPRAVE



(Standardni)
Infrardeči
daljinski
upravljalnik



(Opcijsko)
Žični krmilnik s
tedenskim
časovnikom



A⁺⁺ Hlajenje

A⁺ Ogrevanje (povprečna sezona)

A⁺⁺⁺ Ogrevanje (toplejša sezona)

Koda	Model	Nominalna (min.–max.) zmogljivost hlajenja (kW)	Nominalna (min.–max.) zmogljivost ogrevanja (kW)
398000739	Model notranje enote X31 ECO PLUS AF27 HL	2.70 (0.70 – 3.40)	2.90 (0.60 – 3.50)
398000740	Model zunanje enote X31 ECO PLUS 27 SH LHB		
398000741	Model notranje enote X31 ECO PLUS AF35 HL	3.52 (0.80 – 4.40)	3.80 (1.10 – 4.40)
398000742	Model zunanje enote X31 ECO PLUS 35 SH LHB		
398000743	Model notranje enote X31 ECO PLUS AF52 HL	5.20 (1.26 – 6.60)	5.33 (1.12 – 6.80)
398000744	Model zunanje enote X31 ECO PLUS 52 SH LHB		

X3 MULTISPLIT KLIMATSKE NAPRAVE R32



ARGO DUAL 14 DCI R32
ARGO DUAL 18 DCI R32
ARGO TRIAL 21 DCI R32
ARGO TRIAL 24 DCI R32
ARGO QUADRI 28 DCI R32



ARGO QUADRI 36 DCI R32
ARGO PENTA 42 DCI R32

Koda	Model zunanje enote	Nominalna (min.–max.) zmogljivost hlajenja (kW)	Nominalna (min.–max.) zmogljivost ogrevanja (kW)
398000791	ARGO DUAL 14 DCI R32	4.10 (2.05 – 5.00)	4.40 (2.49 – 5.40)
398000792	ARGO DUAL 18 DCI R32	5.30 (2.14 – 5.80)	5.65 (2.58 – 6.50)
398000793	ARGO TRIAL 21 DCI R32	6.10 (2.02 – 8.30)	6.50 (3.60 – 8.50)
398000794	ARGO TRIAL 24 DCI R32	7.10 (2.30 – 9.20)	8.60 (3.65 – 9.20)
398000795	ARGO QUADRI 28 DCI R32	8.00 (2.30 – 11.00)	9.50 (3.65 – 10.25)
398000796	ARGO QUADRI 36 DCI R32	10.60 (2.60 – 12)	12 (3.00 – 14.00)
398000797	ARGO PENTA 42 DCI R32	12.10 (2.60 – 15.20)	13 (3.00 – 15.50)

Možnost izbire med različnimi tipi notranjih enot in številnimi povezavami.



STENSKA



KASETNE

*WiFi prek žičnega krmilnika



KANALNE

*WiFi prek žičnega krmilnika



TALNE/STROPNE



TALNE

Koda	Model notranje enote	
398000817	STENSKA	X3I ECO PLUS 27 HL WF
398000819		X3I ECO PLUS 35 HL WF
398000821		X3I ECO PLUS 52 HL WF
398000823		X3I ECO PLUS 70 HL WF
398000860	KASETNE	X3I ECO AS 28 HL
398000861		X3I ECO AS 35 HL
398000862		X3I ECO AS 50 HL
398100688		GRID CASSETTE COMPACT
398000863		X3I ECO AS 70 HL
398100677		GRID BIG CASSETTE

Koda	Model notranje enote	
398000856	KANALNE	X3I ECO SD 27 HL
398000857		X3I ECO SD 35 HL
398000858		X3I ECO SD 50 HL
398000859		X3I ECO SD 70 HL
398000666	TALNE/ STROPNE	X3I ECO FC 26 HL
398000667		X3I ECO FC 35 HL
398000668	TALNE	X3I ECO FC 45 HL
398000739		X3I ECO PLUS AF 27 HL
398000741		X3I ECO PLUS AF 35 HL
398000743		X3I ECO PLUS AF 52 HL

DODATKI

Koda	Model
398100673	Krmilnik vrat (razen konzolnih enot)
398100674	Žični krmilnik s tedenskim časovnikom
398100775	Žični krmilnik z omrežjem WiFi (samo kasetni in kanalni)

X3 PAKET: ZUNANJE ENOTE



AEG ECO PLUS 35PIH



AEG ECO PLUS
50PIH AEG ECO
PLUS 71PIH AEG
ECO PLUS 85PIH



AEG ECO PLUS 100PIH
AEG ECO PLUS 100PIH3
AEG ECO PLUS 140PIH
AEG ECO PLUS 140PIH3







AEG ECO PLUS 160PIH3

Koda	Model	Nominalna (min.-max.) zmogljivost hlajenja (kW)	Nominalna (min.-max.) zmogljivost ogrevanja (kW)
398700009	AEG ECO PLUS 35PIH	3.50 (0.90 – 4.69)	4.00 (0.90 – 4.50)
398700010	AEG ECO PLUS 50PIH	5.00 (1.60 – 5.80)	5.50 (1.60 – 6.10)
398700011	AEG ECO PLUS 71PIH	7.00 (2.40 – 7.60)	8.00 (2.20 – 8.60)
398700012	AEG ECO PLUS 85PIH	8.50 (2.90 – 9.00)	8.80 (2.30 – 9.50)
398700013	AEG ECO PLUS 100PIH	10.50 (3.20 – 11)	11.50 (3.00 – 12.50)
398700014	AEG ECO PLUS 100PIH3	10.50 (3.20 – 11)	11.50 (3.00 – 12.50)
398700015	AEG ECO PLUS 140PIH	13.40 (4.00 – 14.20)	15.50 (3.90 – 16)
398700016	AEG ECO PLUS 140PIH3	13.40 (4.00 – 14.20)	15.50 (3.90 – 16)
398700017	AEG ECO PLUS 160PIH3	14.50 (6.80 – 16.80) Kasetne-tla/strop	17.00 (4.50 – 17.50) Kasetne-tla/strop
		16.00 (4.80 – 17.00) kanalna	17.00 (4.50 – 18.00) kanalna

DODATKI

Koda	Model
398100678	Infrardeči daljinski upravljalnik za kanalske enote
398700039	Žični krmilnik z WiFi
398100683	Gateway Modbus
398700041	ON/OFF izklop kontaktnega vmesnika
398100685	Krmilnik vrat za hotel (postopno opuščanje)

X3 PAKET: NOTRANJE ENOTE

Koda	Model	Funkcije	
398700025	ASG ECO PLUS 35PH	<ul style="list-style-type: none"> - 8-smerna kompaktna kasetna s 360° izpustom zraka - Integrirana črpalka za odvajanje kondenzata - Idealno za vgradnjo v lažni strop 	
398100688	GRID CASSETTE COMPACT	Mreža za kompaktno kaseto	
398700026	ASG ECO PLUS 50PH	<ul style="list-style-type: none"> - 8-smerna kasetna s 360° izpustom zraka - Širok spekter nihanja lopute - Integrirana črpalka za odvajanje kondenzata 	
398700027	ASG ECO PLUS 71PH		
398700028	ASG ECO PLUS 85PH		
398700029	ASG ECO PLUS 100PH		
398700030	ASG ECO PLUS 140PH		
398700031	ASG ECO PLUS 160PH		
398100677	GRID BIG CASSETTE	Mreža za veliko kaseto	
398700018	ADG ECO PLUS 35PH	<ul style="list-style-type: none"> - Tanki kanalni, nizek zunanji statični tlak - Tišina - Integrirana črpalka za odvajanje kondenzata 	
398700019	ADG ECO PLUS 50PH	<ul style="list-style-type: none"> - Kanalni, visok zunanji statični tlak - Tišina - Integrirana črpalka za odvajanje kondenzata 	
398700020	ADG ECO PLUS 71PH		
398700021	ADG ECO PLUS 85PH		
398700022	ADG ECO PLUS 100PH		
398700023	ADG ECO PLUS 140PH		
398700024	ADG ECO PLUS 160PH		
398700032	ACG ECO PLUS 35PH	<ul style="list-style-type: none"> - Tla/strop - Dvojna loputa - 11 hitrosti ventilatorja - Širok spekter nihanja lopute 	
398700033	ACG ECO PLUS 50PH		
398700034	ACG ECO PLUS 71PH		
398700035	ACG ECO PLUS 85PH		
398700036	ACG ECO PLUS 100PH		
398700037	ACG ECO PLUS 140PH		
398700038	ACG ECO PLUS 160PH		

X3 FS – TALNE/STOJEČE KLIMATSKE NAPRAVE



Koda	Model notranje enote
398000772	AFSI ECO 120 HL



Code	Model zunanje enote	Zmogljivost hlajenja (kW)	Zmogljivost ogrevanja (kW)
398000773	AFSI ECO 120 SH3	12.5	13.5

VISOKOZMOGLJIVE KANALNE ENOTE – VISOK ZUNANJI STATIČNI TLAK



Koda	Model notranje enote
398700005	ABDGI 20 HW
398700001	ABDGI 25 HW
398700003	ABDGI 30 HW



Koda	Model zunanje enote	Zmogljivost hlajenja (kW)	Zmogljivost ogrevanja (kW)
398700006	ABDGI 20 SH3	20	22
398700002	ABDGI 25 SH3	25	27.5
398700004	ABDGI 30 SH3	30	33

ECOLIGHT PLUS – ENOJNE IN MULTISPLIT KLIMATSKE NAPRAVE



Digitalni daljinski upravljalnik z LCD zaslonom



MODELI NOTRANJNH ENOT

Koda	Model
398000798	ECOLIGHT PLUS 9000 UI
398000800	ECOLIGHT PLUS 12000 UI
398000802	ECOLIGHT PLUS 18000 UI
398000804	ECOLIGHT PLUS 24000 UI

MODELI ZUNANJNH ENOT

Koda	Model	
398000799	ENOJNE	ECOLIGHT PLUS 9000 UE
398000801		ECOLIGHT PLUS 12000 UE
398000803		ECOLIGHT PLUS 18000 UE
398000805		ECOLIGHT PLUS 24000 UE
398000791	MULTI	ARGO DUAL 14 DCI R32
398000792		ARGO DUAL 18 DCI R32
398000793		ARGO TRIAL 21 DCI R32
398000794		ARGO TRIAL 24 DCI R32
398000795		ARGO QUADRI 28 DCI R32
398000796		ARGO QUADRI 36 DCI R32
398000797	ARGO PENTA 42 DCI R32	

Koda	Model
398100676	Dodatna oprema, ki jo je treba naročiti posebej: KIT WIFI

CHARM PLUS – ENOJNE KLIMATSKE NAPRAVE

CHARM DUBBEL – MULTISPLIT KLIMATSKE NAPRAVE



Digitalni daljinski upravljalnik z LCD zaslonom



CHARM PLUS MODELI NOTRANJNH ENOT

Koda	Model	
398000890	ENOJNI	CHARM PLUS 9000 UI
398000892		CHARM PLUS 12000 UI
398000894		CHARM PLUS 18000 UI
398000896		CHARM PLUS 24000 UI

CHARM PLUS MODELI ZUNANJNH ENOT

Koda	Model	
398000891	ENOJNI	CHARM PLUS 9000 UE
398000893		CHARM PLUS 12000 UE
398000895		CHARM PLUS 18000 UE
398000897		CHARM PLUS 24000 UE

Koda	Model
398100774	Dodatna oprema, ki jo je treba naročiti posebej: WIFI KIT FOR ARGO

CHARM DUBBEL MODELI NOTRANJNH ENOT

Koda	Model	
398000899	DUAL	CHARM DUBBEL 9000 UI
398000900		CHARM DUBBEL 12000 UI

CHARM DUBBEL MODELI ZUNANJNH ENOT

Koda	Model	
398000898	DUAL	CHARM DUBBEL 14000 UE

Koda	Model
398100774	Dodatna oprema, ki jo je treba naročiti posebej: WIFI KIT FOR ARGO

NIZKOTEMPERATURNE RAZMERE - ENOJNE SPLIT KLIMATSKE NAPRAVE ZA POSEBNE NAMENE



NASTAVITEV NOTRANJE TEMPERATURE ZRAKA 12 °C

- Doseg je idealen za vse aplikacije, kjer je hlajenje potrebno tudi pri nizki zunanji temperaturi (prostori za zbiranje odpadkov, vinske kleti, cvetličarne, računalniške sobe itd.)
- Tehnologija polnega enosmernega pretvornika
- Digitalni daljinski upravljalnik z LCD zaslonom
- Več prilagoditev pretoka zraka
- Programabilni časovnik
- "Turbo" funkcija: omogoča, da v najkrajšem možnem času doseže predvideno temperaturo
- "Night/Eco" način: udobje med spanjem
- "Memory" funkcija: samodejni ponovni zagon po izpadu električne energije
- "iFeel" funkcija: zagotavlja zeleno temperaturo točno na mestu, kjer je nameščen daljinski upravljalnik
- "Cold Plasma" sistem za čiščenje zraka



Koda	Model	***Zmogljivost hlajenja [kW]	EER
387004104	AWIBS19 – notranja enota	2.6	2.28
387004105	AWICS19 – notranja enota	3.6	2.27
387007235	AEI1G40LL – zunanja enota	-	-

***Nazivni pogoji:
 I Temperatura notranjega zraka 12 °C suhi termometer..... mokri termometer
 Temperatura zunanjega zraka 35 °C suhi termometer

APOLLO – KLIMATSKE NAPRAVE BREZ ZUNANJE ENOTE



APOLLO 12HP in APOLLO 10SC

- Idealno za stavbe z omejitvami urbanističnega načrtovanja
- 4 v 1: hlajenje, ogrevanje (12HP), razvlaževanje, ventilator
- R32, plin z majhnim vplivom na globalno segrevanje
- Tehnologija enosmernega pretvornika
- Integriran WiFi za daljinsko upravljanje funkcij

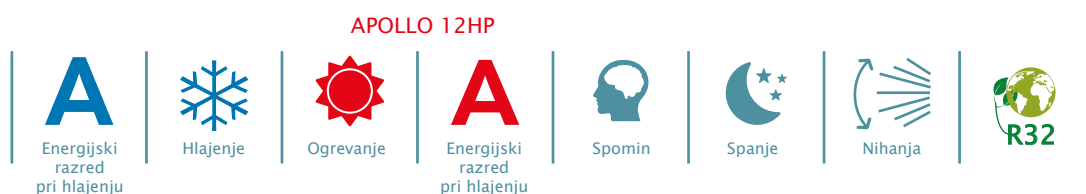

DIMENZIJE

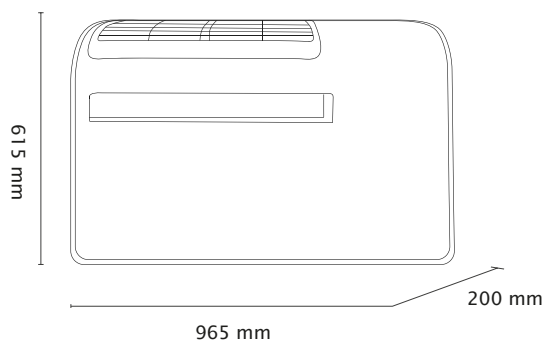

Digitalni daljinski upravljalnik z LCD zaslonom

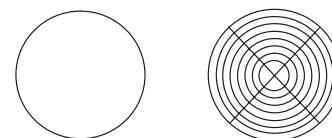

Dve luknji v obodni steni, premera 200 mm, minimalen estetski vpliv

Koda	Model	**Zmogljivost hlajenja [kW]	EER	**Zmogljivost ogrevanja [kW]	COP
398000761	APOLLO12HP	2.35	2.62	2.36	3.10
398000763	APOLLO10SC	2.04	2.61		-

Predstave povezane z (EN14511):

* Zmogljivost hlajenja: zunanja temp. zraka 35 °C, notranja temp. zraka 27 °C
 Zmogljivost ogrevanja: zunanja temp. zraka 7 °C, notranja temp. zraka 20 °C

Koda	Model dodatne opreme
398100689	Komplet za vgradnjo lukenj 160 mm

DD – KLIMATSKE NAPRAVE BREZ ZUNANJE ENOTE

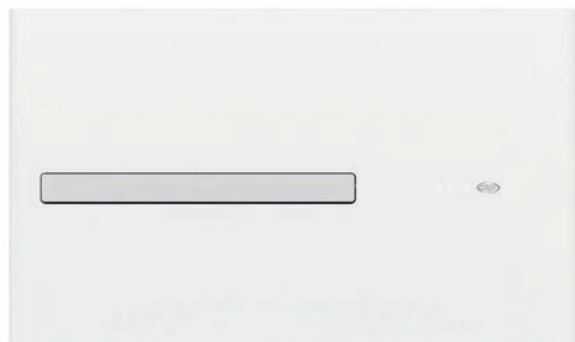

DD ON/OFF in DD FULL DC PRETVORNIK

- Prefinjen dizajn, visokokakovostni materiali
- 5 v 1: toplotna črpalka in klimatska naprava s funkcijami razvlaževanja, čiščenja in ventilatorja
- Idealno za stavbe z urbanimi omejitvami
- Fleksibilna montaža: nizka ali visoka stena.
- Poseben filter titanovega dioksida (filter TiO₂)
- Izvedba z metakrilatno ali aluminijasto barvano ploščo

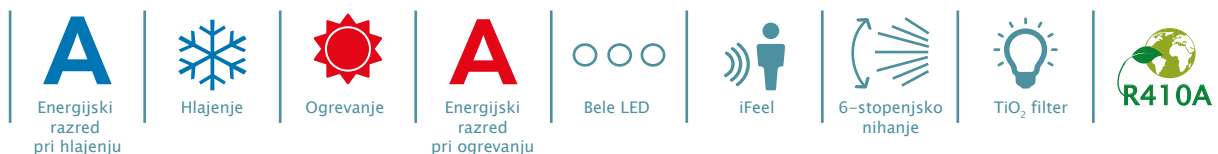

DIMENZIJE

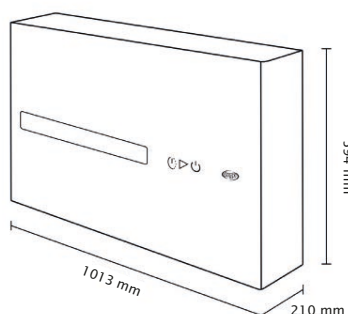

Daljinski upravljalnik z mehkim dotikom, naročen posebej

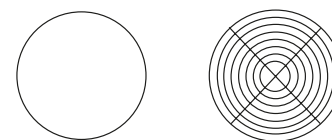

Dve luknji v obodni steni, premera 160 mm, minimalen estetski vpliv

Koda	Model	*Zmogljivost hlajenja nom. (min.-max.) [kW]	EER	*Zmogljivost ogrevanja [kW]	COP
397002947	DD ON/OFF	2.30	2.70	2.30	3.10
397002948	DD DCI Polni enosmerni pretvornik	2.3 (1.1 – 2.7)	2.70	2.3 (1.1 – 2.7)	3.10
397002953	DD DCI ALUMINIUM Polni enosm.pretvornik	2.3 (1.1 – 2.7)	2.70	2.3 (1.1 – 2.7)	3.10

Predstave povezane z (EN14511):

* Zmogljivost hlajenja: zunanja temp. zraka 35 °C, notranja temp. zraka 27 °C
Zmogljivost ogrevanja: zunanja temp. zraka 7 °C, notranja temp. zraka 20 °C

ULISSE ECO – SPLIT KONZOLE



- Samo 24 cm globine, ta posebna klimatska naprava je opremljena s tehnologijo Full DC Inverter iSERIES.
- Zahvaljujoč posebni hitri povezavi Aeroquip, certificirani za R32, za namestitev ali prenos ni potrebno posredovanje monterja.
- Kondenzat se upari skozi zunanji ohišje, zato kondenzata ni treba odvajati.
- Opremljen z učinkovitim kompresorjem Twin Rotary Inverter, je Ulisse Eco zaradi ustrezno izbranih komponent še posebej tih
- Novi daljinski upravljalnik z mehkim dotikom z inovativnim konceptom enoti dodaja pomembne funkcije.
- Na voljo tudi z integriranim WiFi in namensko aplikacijo.

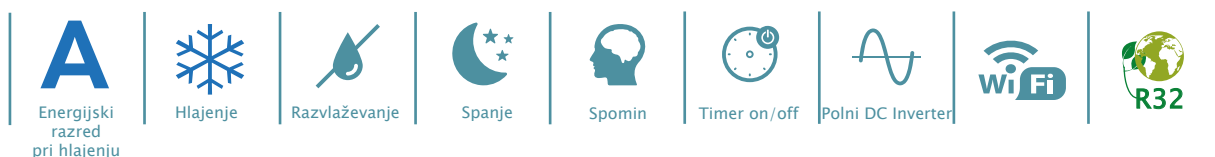

DIMENZIJE

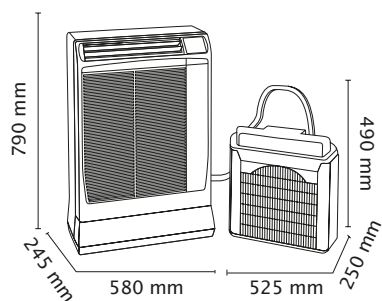

Daljinski upravljalnik z mehkim dotikom, ki je priložen enoti

Koda	Model	*Max zmogljivost hlajenja [kW]	SEER
397028967	ULISSE ECO – FULL DC Inverterska klimatska naprava z R32 – infrardeči daljinski upravljalnik z vgrajenim temperaturnim senzorjem – dolžina hladilne cevi 1,8 m	4.00	5.2
397028973	ULISSE ECO WiFi – FULL DC inverter klimatska naprava z R32 – infrardeči daljinski upravljalnik z vgrajenim temperaturnim senzorjem – dolžina hladilne cevi 1,8 m – WiFi integrato	4.00	5.2
387027191	Ulisse Bracket komplet	-	-
397016929	2-metrski komplet za podaljševanje cevi	-	-
397016930	4-metrski komplet za podaljševanje cevi	-	-

* Zmogljivost, povezana z zmogljivostjo hlajenja: temperatura zunanjega zraka 35 °C, temperatura zraka v zaprtih prostorih 27 °C

- Cenik velja od 10.4.2023 do preklica. Cene so v EUR brez DDV-ja. Prevoz vključen v ceno.
- Pred naročilom preverite zalogo oz. dobavni rok, cene in prodajne pogoje.
- Pridružujemo si pravico do spremembe cene v primeru tiskarske napake oz. v primeru povišanja cen s strani dobavitelja.
- Naročila: teja.ipavec@jadrannergetika.si; david.tavcar@jadrannergetika.si
- Rezervni deli in servis: servis@jadrannergetika.si